



Selection: Semi-hermetic Reciprocating Compressors

Input Values

Compressor model	(66F-80.2Y)	Suction gas temperature	20,00 °C
Mode	Refrigeration and Air conditioning	Operating mode	Auto
Refrigerant	R404A	Power supply	400V-3-50Hz
Reference temperature	Dew point temp.	Capacity control	100%
Liq. subc. (in condenser)	0 K	Useful superheat	100%

Result

Q [W]	Cooling capacity	COP [-]	COP/EER
Qu* [W]	Evaporator capacity	m [kg/h]	Mass flow
P [kW]	Power input	Op.	Operating mode
I [A]	Current	th [°C]	Discharge gas temp. w/o cooling
Qc [W]	Condenser capacity		

tc	to	-5°C	-10°C	-15°C	-20°C	-25°C	-30°C	-35°C	-40°C
30°C	Q [W]	237462	196080	160257	129356	102823	80164	60937	44737
	Qu* [W]	237462	196080	160257	129356	102823	80164	60937	44737
	P [kW]	62,9	59,5	55,4	50,7	45,7	40,3	34,7	29,0
	I [A]	113,9	109,2	103,8	97,7	91,2	84,5	78,0	71,9
	Qc [W]	300381	255549	215629	180093	148494	120448	95617	73708
	COP [-]	3,77	3,30	2,89	2,55	2,25	1,99	1,76	1,54
	m [kg/h]	5965	4877	3953	3168	2504	1942	1470	1076
	Op.	Standard	Standard	Standard	Standard	Standard	Standard	Standard	Standard
	th [°C]	70,4	77,1	84,2	91,8	100,0	109,0	118,9	130,4
40°C	Q [W]	201799	166180	135268	108548	85566	65912	49214	35133
	Qu* [W]	201799	166180	135268	108548	85566	65912	49214	35133
	P [kW]	72,0	66,8	61,2	55,1	48,7	42,1	35,5	28,8
	I [A]	126,3	119,2	111,5	103,4	95,1	86,8	78,9	71,7
	Qc [W]	273794	233027	196446	163643	134273	108036	84667	63935
	COP [-]	2,80	2,49	2,21	1,97	1,76	1,56	1,39	1,22
	m [kg/h]	5713	4652	3751	2987	2339	1791	1331	947
	Op.	Standard	Standard	Standard	Standard	Standard	Standard	Standard	Standard
	th [°C]	81,5	88,4	95,6	103,4	111,8	121,1	131,6	0
50°C	Q [W]	--	136619	110590	88051	68648	52054	37968	26111
	Qu* [W]	--	136619	110590	88051	68648	52054	37968	26111
	P [kW]	--	73,4	66,1	58,7	51,0	43,2	35,5	28,0
	I [A]	--	128,2	118,3	108,1	98,0	88,2	79,0	70,9
	Qc [W]	--	209975	176737	146702	119624	95285	73492	54075
	COP [-]	--	1,86	1,67	1,50	1,35	1,20	1,07	0,93
	m [kg/h]	--	4423	3542	2794	2162	1629	1182	809
	Op.	--	Standard	Standard	Standard	Standard	Standard	Standard	Standard
	th [°C]	--	99,9	107,3	115,4	124,2	134,0	0	0



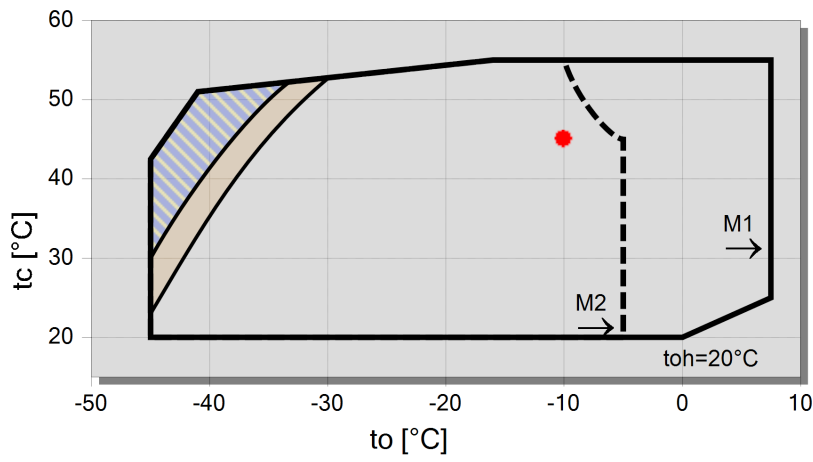

-- No calculation possible (see message in single point selection)

*According to EN12900 (20°C suction gas temp., 0K liquid subcooling)

Application Limits 100% 66F-80.2



Legend

-  additional cooling & suction gas superheat $\leq 20K$
-  additional cooling or max. $t_{oh} < 0^\circ C$
-  M1: motor 1
-  M2: motor 2
-  A



Technical Data: (66F-80.2Y)

Dimensions and Connections

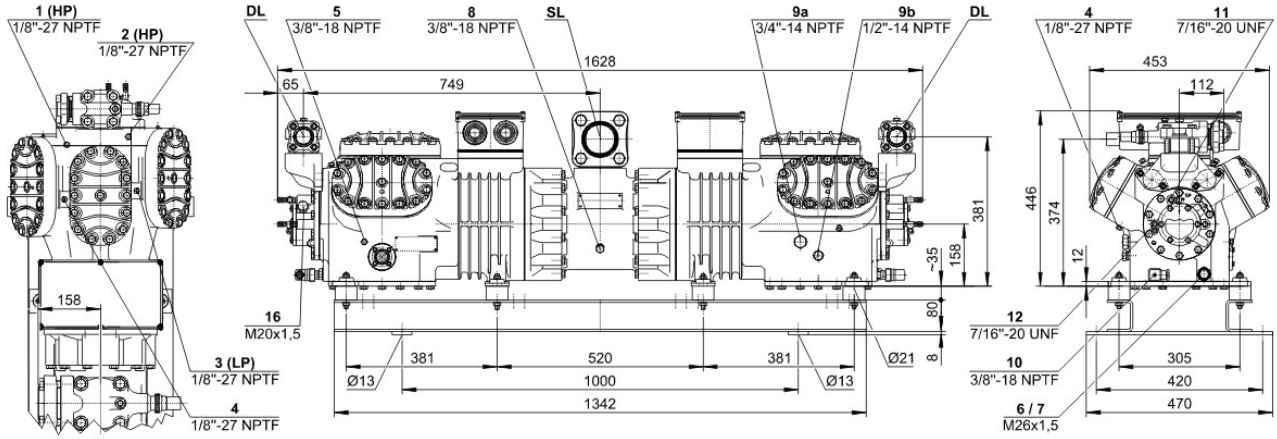



Technical Data

Technical Data

Displacement (1450 RPM 50Hz)	303,2 m ³ /h
Displacement (1750 RPM 60Hz)	365,9 m ³ /h
No. of cylinder x bore x stroke	6+6 x 82 mm x 55 mm
Weight	519 kg
Max. pressure (LP/HP)	19 / 28 bar
Connection suction line	76 mm - 3 1/8"
Connection discharge line	2x42 mm - 1 5/8"
Connection cooling water	R 3/4"
Oil type R134a/R407C/R404A/R507A/R407A/R407F	tc<55°C: BSE32 tc>55°C: BSE55 (Option)
Oil type R22 (R12/R502)	B5.2 (Standard)

Motor data

Motor voltage (more on request)	380-420V PW-3-50Hz
Max operating current	2x78.0 A
Winding ratio	50/50
Starting current (Rotor locked)	2x180.0 A Y / 2x323.0 A YY
Max. Power input	2 x 38,6 kW

Extent of delivery (Standard)

Motor protection	SE-B2
Enclosure class	IP54 (Standard), IP66 (Option)
Vibration dampers	Standard
Oil charge	9,50 dm ³

Available Options

Connection suction line	Option
Discharge shut-off valve	Option
Discharge gas temperature sensor	Option
Start unloading	Option
Capacity control	100-83-66-33-17% (Option)
Additional fan	Option
Water-cooled cylinder heads	Option
CIC System	Option
Oil service valve	Option
Crankcase heater	2 x 140 W (Option)
Oil pressure monitoring	MP54 (Option), Delta-PII (Option)

Sound measurement

Sound power level (-10°C / 45°C)	86,0 dB(A) @ 50Hz
Sound power level (-35°C / 40°C)	94,5 dB(A) @ 50Hz
Sound pressure level @ 1m (-10°C / 45°C)	78,0 dB(A) @ 50Hz
Sound pressure level @ 1m (-35°C / 40°C)	86,5 dB(A) @ 50Hz



Semi-hermetic Reciprocating Compressors

Motor 1 = e.g. 4TES-12 with 12"HP", primary for air-conditioning (e.g. R22,R407C) and air-conditioning with R134a at high ambient temperatures.

Motor 2 = e.g. 4TES-9 with 8"HP", universal Motor for medium and low temperature application (e.g. R404A, R507A, R407A, R407F) and air-conditioning with R134a

Motor 3 = e.g. 4TES-8, for medium temperature applications and R134a

For more information concerning the application range use the "Limits" button.

Operation modes 4VES-7 to 6FE-44 and 44JE-30 to 66FE-88 with R407F/R407A/R22

CIC = liquid injection with low temperature application, suction gas cooled motor.

ASERCOM certified performance data

The Association of European Refrigeration Component Manufacturers has implemented a procedure of certifying performance data. The high standard of these certifications is assured by:

- * plausibility tests of the data performed by experts.
- * regular measurements at independent institutes.

These high efforts result in the fact that only a limited number of compressors can be submitted. Due to this not all BITZER compressors are certified until now. Performance data of compressors which fulfil the strict requirements may carry the label "ASERCOM certified". In this software you will find the label at the respective compressors on the right side below the field "result" or in the print out of the performance data. All certified compressors and further information are listed on the homepage of ASERCOM.

Condensing capacity

The condensing capacity can be calculated with or without heat rejection. This option can be set in the menu Program Options. The heat rejection is constantly 5% of the power consumption. The condensing capacity is to be found in the line Condensing cap. (with HR) resp. Condensing capacity.

Data for sound emission

Data based on 50HZ application (IP-units 60Hz) and R404A if not declared.

Sound pressure level: values based on free field area conditions with hemispherical sound emission in 1 meter distance.

General remarks regarding sound data

Listed sound data were measured under testing conditions in our laboratory. For this purpose the free-standing test sample is mounted on a solid foundation plate and the pipework is connected vibration-free to the largest extend possible. Suction and discharge lines are fixed in a flexible configuration, such that a transmission of vibrations to the environment can be largely excluded. In real installations considerable differences might be observed, compared to the measurements in the laboratory. The airborne sound emitted by the compressor can be reflected from surfaces of the system and this may increase the airborne sound level measured close to the compressor. Vibrations caused by the compressor are also transferred to the system by the compressor feet and piping depending on the damping ratio of the fixings. Thus, the vibrations can induce other components to such an extent that these components contribute to an increase in airborne sound emission. If required, the transfer of vibrations to the system can be minimized by suitable fixing and damping elements.

Legend of connection positions according to "Dimensions":

- 1 High pressure connection (HP)
- 2 Connection for discharge gas temperature sensor (HP) (for 4VE(S)-6Y .. 4NE(S)-20(Y) connection for CIC sensor as alternative)
- 3 Low pressure connection (LP)
- 4 CIC system: injection nozzle (LP)
- 4b Connection for CIC sensor
- 4c Connection for CIC sensor (MP / operation with liquid subcooler)
- 5 Oil fill plug
- 6 Oil drain
- 7 Oil filter (magnetic screw)
- 8 Oil return (oil separator)
- 8* Oil return with NH3 and insoluble oil
- 9 Connection for oil and gas equalization (parallel operation)
- 9a Connection for gas equalization (parallel operation)



- 9b Connection for oil equalization (parallel operation)
 - 10 Oil heater connection
 - 11 Oil pressure connection +
 - 12 Oil pressure connection –
 - 13 Cooling water connection
 - 14 Intermediate pressure connection (MP)
 - 15 Liquid injection (operation without liquid subcooler and with thermostatic expansion valve)
 - 16 Connection for oil monitoring (opto-electrical oil monitoring "OLC-K1" or differential oil pressure switch "Delta-PII")
 - 17 Refrigerant inlet at liquid subcooler
 - 18 Refrigerant outlet at liquid subcooler
 - 19 Clamp space
 - 20 Terminal plate
 - 21 Maintenance connection for oil valve
 - 22 Pressure relief valve to the atmosphere (discharge side)
 - 23 Pressure relief valve to the atmosphere (suction side)
 - 24 IQ MODULE
 - SL Suction gas line
 - DL Discharge gas line
- Dimensions can show tolerances according to EN ISO 13920-B.